

LUBRICATE ALL SEALS WITH CLEAN HYDRAULIC OIL PRIOR TO ASSEMBLY.
DO NOT USE SILICONE BASED LUBRICANTS.

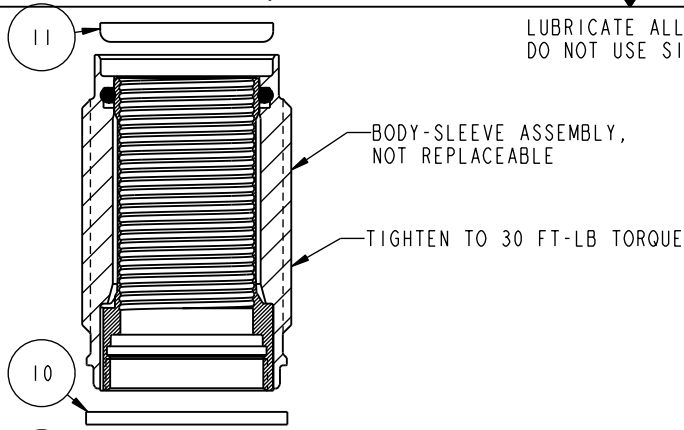

BODY-SLEEVE ASSEMBLY,
NOT REPLACEABLE

TIGHTEN TO 30 FT-LB TORQUE



APPLY MEDIUM STRENGTH
THREAD LOCKER (BLUE) TO THREADS.
TIGHTEN TO 11 IN-LB TORQUE.

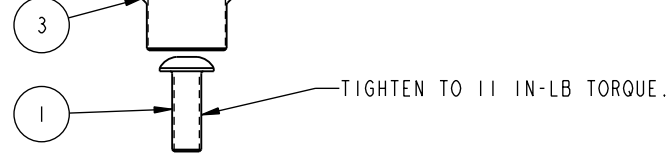

TIGHTEN TO 11 IN-LB TORQUE.

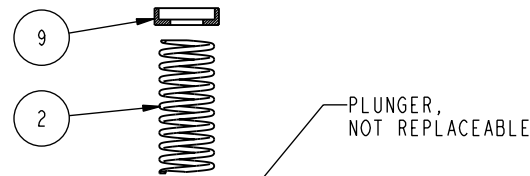

PLUNGER,
NOT REPLACEABLE

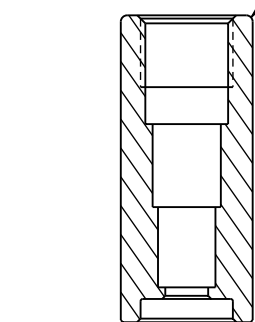

APPLY MEDIUM STRENGTH
THREAD LOCKER (BLUE) TO THREADS.
TIGHTEN TO 80 IN-LB TORQUE.

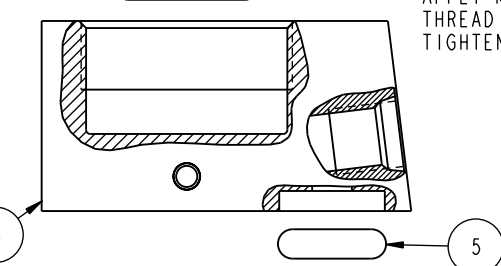
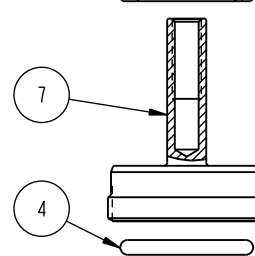

N/A	N/A	IS1014	INSTRUCTION SHEET, WS, AA, 1000&4.4KN			
N/A	N/A	61100113	KIT, SPRING, WS, AA, 1000&4.4KN			
N/A	N/A	6V100533	KIT, SEAL, WS, SPR & AA, 1000&4.4KN, FKM			
N/A	N/A	60100533	KIT, SEAL, WS, SPR & AA, 1000&4.4KN			
11	1	39V50039	WIPER, PRESS-IN	X	X	
10	1	39H55012	GASKET	X	X	
9	1	81070600	SPACER, WS, 1000, AIR			X
8	1	81040601	ASSY, BASE, WS, SPR&AA, MM, 1000			
7	1	81030608	RETAINER, WS, AA, 1000&4.4KN			
6	1	39051057	O-RING	X	39V51057	
5	1	39000068	O-RING	X	39V00068	
4	1	39000039	O-RING	X	39V00039	
3	1	30802314	INSERT, THD, 7/16-20, WS, AA, 1000			
2	1	23350008	SPRING			X
1	1	21410076	BUTTON HEAD CAP SCREW			X
No.	QTY	PART No.	DESCRIPTION	Included in Std. Seal Kit	Included in FKM Seal Kit	Included in Spring Kit

PARTS LIST



VEKTEK, INC.
1334 E. SIXTH AVE. P.O. BOX 625
EMPORIA, KS. 66801 U.S.A.

ASSEMBLIES AFFECTED

10060612

10060612F

PARTS LIST, ASSY, WS, AA, MM, 1000

SIZE
A

PL1075

REV
A

SHEET 1 OF 1

A	2018	RELEASE	JDW	6-1-09
REV	IN ACCORDANCE WITH ECN	EFFECTIVE DATE	REVISED BY	DATE
DRW BY:	JDW	DRAWING STATUS: Released		
DATE:	6-1-09	PRODUCTION APPROVED FOR RELEASED STATUS ONLY		

FORM FEG035_PL_ASIZE, REV. A

Vekttek, Inc. 1334 East Sixth Ave. P.O. Box 625 Emporia, Ks. 66801 U.S.A.	Instruction Sheet	IS1014	
		REVISION:	A , I.A.W. ECN2017
		BY/DATE:	JDW 5-20-09
		APPR/DATE:	JAM 6-1-09
TITLE: Disassembly/Assembly: 1000 lb & 4.4 kN Air Advance Work Supports			

Read all instructions before disassembly

Refer to the illustration on page three for component numbers and a tool list.

Disassembly

Notice: When disassembling multiple work supports, the plunger and body/sleeve assembly from each work support should be kept together.

1. Clamp the work support base (1) in a vise. Cartridge mounted work supports must remain in their fixture for steps two and three.
2. Connect a hydraulic power supply to the work support. Apply hydraulic pressure (approximately 1000 psi) to lock the plunger (2) in place.
3. Remove the threaded insert (3) from the plunger (2).
4. Release the hydraulic pressure and disconnect the hydraulic line.
5. Remove the body/sleeve assembly (5) from the base (1) or fixture.
Caution--Use a six-point socket only. Other types of wrenches may damage the work support.
6. Remove O-ring (11) and gasket (8).
7. Unscrew cap screw (10) and remove spacer (12) and spring (7) from the plunger (2).
8. Unscrew the retainer (6) from the body/sleeve assembly (5).
9. Slide the plunger (2) out of the body/sleeve assembly (5).
10. Remove O-ring (4) from the internal groove in the body/sleeve assembly (5).
11. Remove the wiper (9) from the body/sleeve assembly (5). **Caution--Do not damage the inner sleeve of the body/sleeve assembly (5).**
12. Clean all parts thoroughly and set aside to dry.

Vekttek, Inc. 1334 East Sixth Ave. P.O. Box 625 Emporia, Ks. 66801 U.S.A.	Instruction Sheet	IS1014		
		REVISION:	A , I.A.W. ECN2017	
		BY/DATE:	JDW	5-20-09
		APPR/DATE:	JAM	6-1-09
TITLE: Disassembly/Assembly: 1000 lb & 4.4 kN Air Advance Work Supports				

Assembly

1. Before assembly, lubricate the gasket (8) and O-rings (4) & (11) with clean hydraulic oil (Vekttek 65-0010-01 or equivalent). Apply Loctite primer N® or equivalent to the threads of the threaded insert (3), retainer (6) and allow to dry.
2. Press the wiper (9) into the body/sleeve assembly (5), using only enough force to seat the wiper in the counterbore. **Caution--Excess force may cause the inner sleeve to collapse.**
3. Insert the retainer (6) into the plunger (2).
4. Install the spring (7) and then spacer (12) onto the retainer (6). Apply one drop of low strength Loctite 222® or equivalent, to the cap screw (10) threads and tighten to the torque specification on the parts list.
5. Place the O-ring (4) into the internal groove in the body/sleeve assembly (5). Apply one drop of medium strength Loctite 243® or equivalent, to the retainer (6) threads and insert the plunger (2) and retainer (6) assembly into the body/sleeve assembly (5). Tighten to the torque specification on the parts list.
6. Install the O-ring (11) on the retainer (6), and the gasket (8) into the bottom of the base (1) or fixture cavity.
7. Insert the body/sleeve assembly (5) into the base (1) or fixture cavity and tighten to the torque specification on the parts list. **Caution--Use a six-point socket only. Other types of wrenches may damage the work support.**
8. Connect the hydraulic power supply to the work support. Apply hydraulic pressure (approximately 1000 psi) to lock the plunger (2) in place.
9. Apply one drop of medium strength Loctite 243® or equivalent to the threaded insert (3) and tighten to the torque specification on the parts list.
10. Release the pressure and disconnect the hydraulic line.

Vekttek, Inc. 1334 East Sixth Ave. P.O. Box 625 Emporia, Ks. 66801 U.S.A.	Instruction Sheet		IS1014	
			REVISION:	A, I.A.W. ECN2017
	BY/DATE:	JDW	5-20-09	
	APPR/DATE:	JAM	6-1-09	
TITLE: Disassembly/Assembly: 1000 lb & 4.4 kN Air Advance Work Supports				

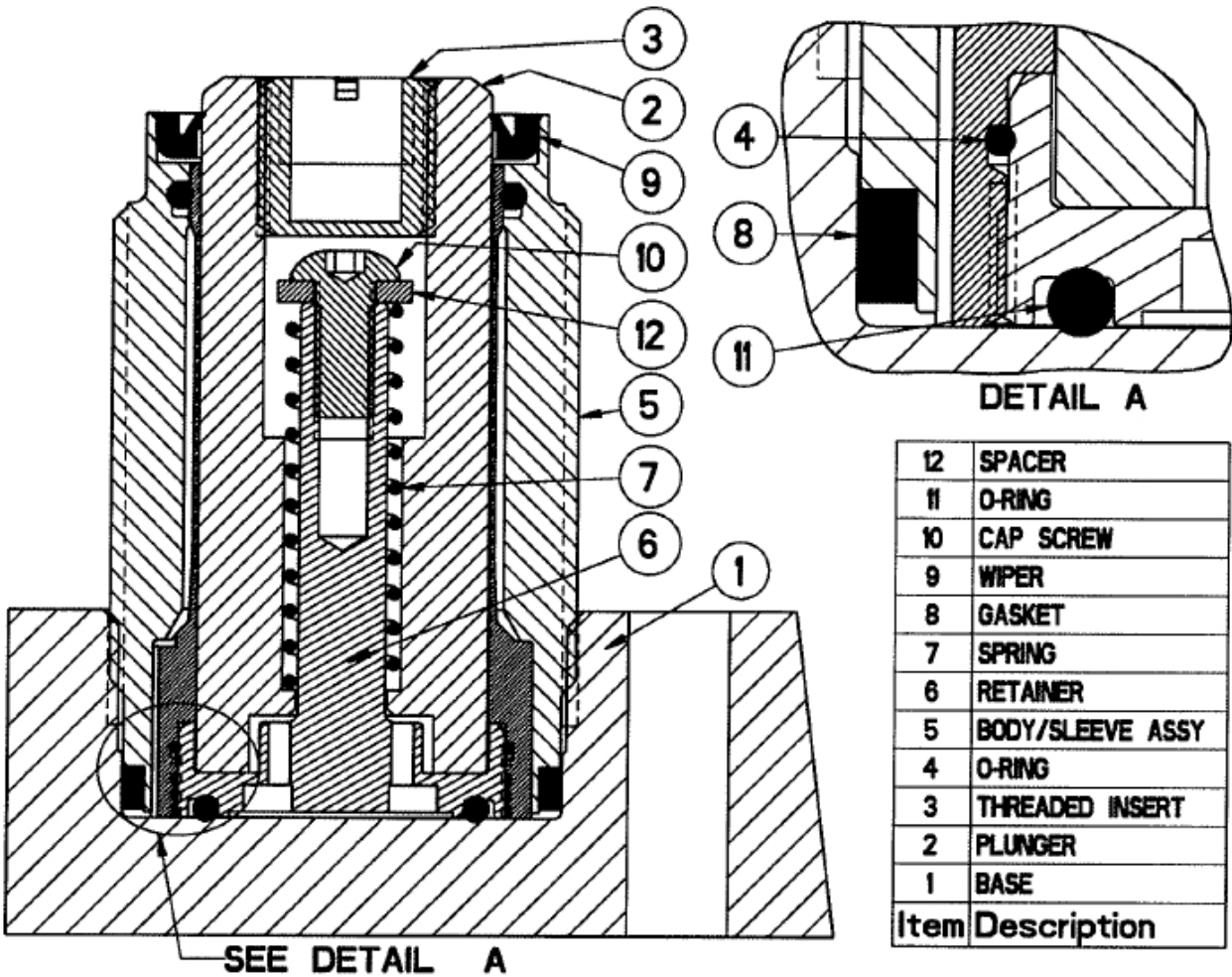

Model Number	Tool List
10060610 10060611 10060612	5/64 hex key, spanner wrench, screwdriver, 7/8 socket (6 pt)
41006107 41006007 6964L-04-1 6964L-04-2	2mm hex key, spanner wrench, screwdriver, 23mm socket (6 pt)